



INSTALLATION & OPERATION MANUAL

RCB
INFRARED GAS
BROILER

CONGRATULATIONS!



Thank you for choosing Trueheat.

This product has been specifically designed by Comcater to meet a wide range of applications and represents the best quality and highest value equipment.

Please read the instruction manual carefully to ensure the safe and reliable operation and performance of your equipment.

Should you require service, you will be supported by Comcater's trained and qualified service network.

COMCATER AUSTRALIA

www.comcater.com.au

National Head Office

156 Swann Drive, Derrimut, VIC 3030

Phone: 03 8369 4600

Fax: 03 8369 4699

Email: sales@comcater.com.au

Technical Services Group

Phone: 1800 810 161

Fax: 03 8369 4696

Email:

[Equipment Servicing \(24/7\)](mailto:Equipment Servicing (24/7)@comcater.com.au)

service@comcater.com.au

Equipment Spare Parts

spares@comcater.com.au

Technical Support

techsupport@comcater.com.au

Comcater QR Codes



Comcater Website



Log a Service Call



Online Spare Parts Store

Reproduction or copying of any part of this manual by any means whatsoever is strictly forbidden unless authorised in writing by Comcater. Comcater reserves the right to change design and specifications without prior notice. © Copyright Comcater Pty Ltd, August 2017.

TABLE OF CONTENTS



INTRODUCTION	
Warranty.....	4
Date Plate Location	4
WARNINGS	5
GENERAL INFORMATION	6
SPECIFICATIONS	
Dimensions, Weight & Installation Drawings.....	7
Accessories & Optional Accessories	7
Gas Configuration	8
INSTALLATION	
Gas Connection	11
Installation Clearances	11
Levelling	11
CONVERSION INSTRUCTIONS	12
COMMISSIONING / BURNER ADJUSTMENT	
Leak Test	12
Test Point Pressure	12
Pilot Adjustment	12
Target Adjustment	12
OPERATION	
First Time Use	13
Daily Operation	13
MAINTENANCE	
Daily Cleaning	14
Recommended Service Plan	15
TROUBLESHOOTING	
Burner will not light	16
Broiler isn't getting hot	16

INTRODUCTION



GENERAL

This Trueheat RC Series is designed for commercial catering purposes only and is designed to deliver high end performance to fulfill the busy demands within a commercial kitchen. incorporates a wide range of design features. It is available in various appliances and configurations including: Ranges with open burners, griddles and oven and as a top only unit.

Barbecues, salamanders, pasta cookers and deep fryers.

This versatility will satisfy a wide range of customer needs.

WARRANTY

12 months replacement of parts including labour, for goods found to be faulty due to defective materials, manufacture and/or workmanship. This warranty is void if installation, operation and/or maintenance of the equipment are not in accordance with manufacturer's instructions and recommendations.

Unauthorised modifications to the equipment will void the warranty and product certification.

All warranty work will be undertaken in normal working hours from Monday – Friday 8:00am to 4:00pm

Warranty does not extend to:

Damages caused in shipment

Damage as a result of incorrect installation

Damage as a result of incorrect operation

Damages caused by Unauthorised service and use of non-original parts

Gas supply issues to the equipment

Calibration of thermostats after 90 days

Failure resulting from improper maintenance

Failure as a result of tampering with, removal of, or changing any pre-set control or safety device

After hours Service - **Penalty rates apply for afterhours service.**

Conditions as defined in Comcater terms and condition of sale, a copy of Comcater's terms and conditions of sale can be found at www.comcater.com.au/terms

For all warranty work, authorized service, genuine and authorized spare parts, please contact Comcater Service 1800 810 161.





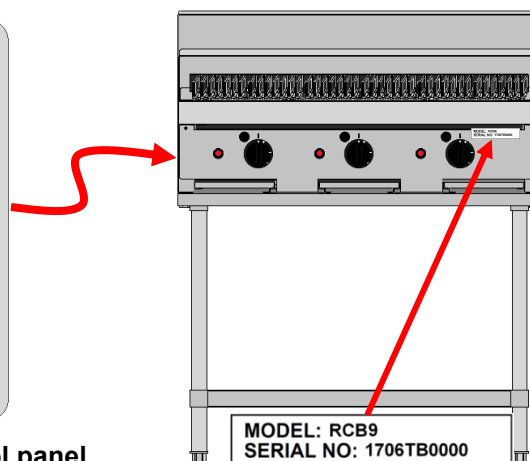
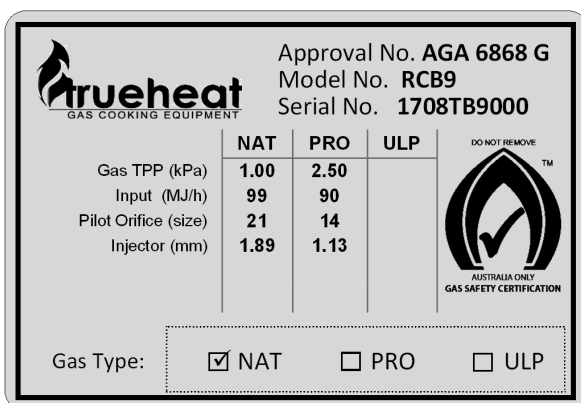



Please ensure you quote the Model and Serial Number of the unit.

The Model and Serial Number of the unit is recorded on the sales invoice, and also shown on the top right side of the front control panel. The data plate is located behind the front control panel.



NOTE: Data Plate is located behind the control panel

WARNINGS

	<p>IMPROPER INSTALLATION, ADJUSTMENT, ALTERATION, SERVICE OR MAINTENANCE CAN CAUSE INJURY OR DEATH. THE INSTRUCTION MANUAL MUST BE READ CAREFULLY BEFORE INSTALLING, OPERATING OR SERVICING THIS EQUIPMENT.</p>
	<p>TO BE INSTALLED ONLY BY AN AUTHORISED PERSON IN ACCORDANCE WITH AS 5601, LOCAL AUTHORITY, GAS, ELECTRICITY, ANY APPLICABLE STATUTORY REGULATIONS AND MANUFACTURER REQUIREMENTS.</p>
	<p>THIS EQUIPMENT IS DESIGNED FOR COMMERCIAL CATERING PURPOSES AND WILL GENERATE SIGNIFICANT HEAT. HOT SURFACES WILL CAUSE BURNS. A HAZARD AND RISK ASSESSMENT MUST BE UNDERTAKEN BY OWNERS AND ALL OPERATORS MADE AWARE OF THESE.</p>
	<p>DO NOT STORE OR USE FLAMMABLE LIQUIDS NEAR THIS APPLIANCE.</p>
	<p>DO NOT SPRAY AEROSOLS NEAR THIS APPLIANCE WHILE IT IS IN OPERATION.</p>
	<p>INSTALLATION CLEARANCES AS SPECIFIED MUST BE OBSERVED.</p>
	<p>IF YOU SMELL GAS, TURN THE UNIT OFF AND THE MAIN GAS SUPPLY VALVE TO THE UNIT. CONTACT YOUR GAS SUPPLIER OR AN AUTHORISED PERSON.</p>
	<p>BEFORE TURNING ON THE MAIN GAS SUPPLY, CHECK THE UNIT TO BE CERTAIN THAT ALL THE VALVES ARE IN THE “OFF” POSITION.</p>

GENERAL INFORMATION



INSPECTION

Please inspect the unit on receipt. If the unit is damaged, contact the carrier immediately and file a damage claim with them. Save all packing materials when filing a claim. Freight damage claims are the responsibility of the purchaser and are not covered under warranty.

OPERATOR MANUAL

This manual contains important information for your safety and the installation, operation, maintenance and service of this equipment. Please read the manual carefully and ensure all operators of the equipment are aware of the contents and safety requirements. You must also assess all hazards and risks associated with the operation of the equipment in your environment and advise all operators of these.

INSTALLATION

This equipment must be installed by an authorized person in accordance with AS 5601, local authority, gas, electricity, any applicable statutory regulations and manufacturer requirements.

GAS CONNECTION

The appliance must be connected by an authorized person to the gas type specified on the unit. The gas type is shown adjacent to the rear gas connection point and on the data plate. Connect to and use only the correct type of gas.

GAS PRESSURE

The authorized person installing this equipment must ensure that the gas operating pressure is the same as shown on the rating plate and that there is sufficient gas volume for the appliance to operate correctly.

COMMISSIONING

The authorized person installing this equipment must commission the equipment in accordance with AS 5601 - gas leakage, operational checking, adjustments and instructing the owner on use of the equipment are prescribed requirements.

SPECIFICATIONS



DIMENSIONS, WEIGHT & INSTALLATION DRAWINGS, OPTIONAL ACCESSORIES

The following tables and drawings provide all dimension, weight and optional accessories.

DESCRIPTION	RCB4	RCB6	RCB9
Weight (kg)	56	92	132
Width (mm)	400	600	900
Depth (mm)	803	803	803
Height (mm)	445	445	445
Height on stand (mm)	1135	1135	1135

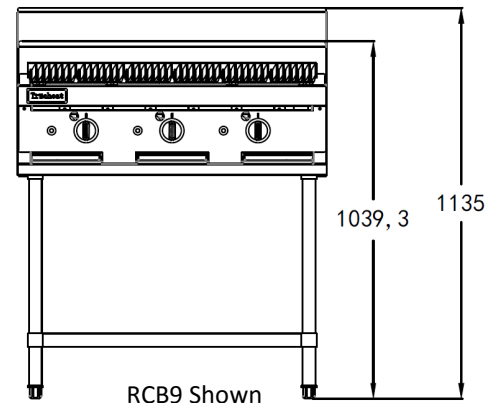
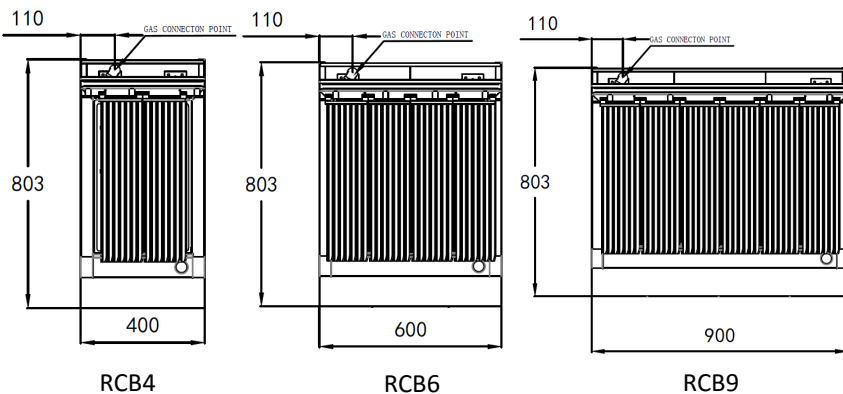
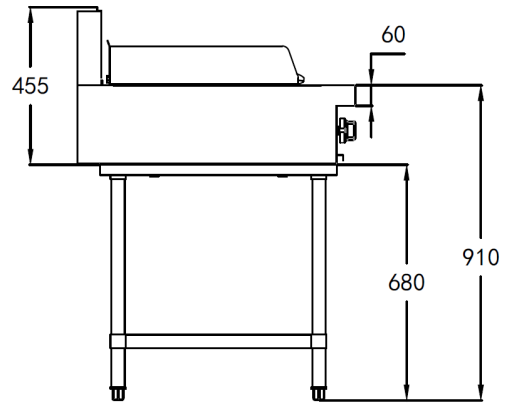

IMAGE	PART NO.	DESCRIPTION	Qty
	RCSTD4	400mm Stand complete with shelf, Suits RCB4 Counter-Top models	1
	RCSTD6	600mm Stand complete with shelf, Suits RCB6 Counter-Top models	1
	RCSTD9	900mm Stand complete with shelf, Suits RCB9 Counter-Top models	1
	THSP-B05002	Adjustable legs for RCT Counter-Top mounting only	4
	432018-900HK	900mm 3/4" flexible gas hose with quick connect fittings & restraint	1
	432018-1200HK	1200mm 3/4" flexible gas hose with quick connect fittings & restraint	

SPECIFICATIONS (cont'd)

GAS CONFIGURATION

	TO BE COMPLETED BY AN AUTHORISED PERSON.
---	---

DESCRIPTION	NATURAL GAS	PROPANE GAS
Minimum Gas Inlet Pressure	1.13 kPa	2.75 kPa
Test Point Pressure	1.00 kPa	2.50 kPa
Main Injector	1.89 mm	1.13 mm
Pilot Orifice	Size 21	Size 14
Low Flame Adjustment	3 turns out from fully in	3 turns out from fully in
Commissioning Procedure - Regulator Adjustment	Set the gas pressure at the main gas valve while the burner is running.	Set the gas pressure at the main gas valve while the burner is running.

Note: When checking gas pressure, ensure that all other equipment on the same line is turned "ON".

	ONLY CONNECT THE APPLIANCE TO THE GAS TYPE IT HAS BEEN CONFIGURED FOR. THE GAS TYPE IS SPECIFIED ON THE DATA PLATE AND AT THE REAR OF THE APPLIANCE.
---	---

NOMINAL GAS CONSUMPTION

MODELS	NATURAL GAS	PROPANE GAS
RCB4	33 MJ/h	30 MJ/h
RCB6	66 MJ/h	60 MJ/h
RCB9	99 MJ/h	90 MJ/h

INSTALLATION



THIS EQUIPMENT MUST BE INSTALLED BY AN AUTHORIZED PERSON IN ACCORDANCE WITH AS 5601, LOCAL AUTHORITY, GAS, ELECTRICITY, ANY APPLICABLE STATUTORY REGULATIONS AND MANUFACTURER REQUIREMENTS.

Note: Installation is the responsibility of the owner.

GAS INLET CONNECTION

3/4" BSP Female.

GAS CONNECTION POINT

The gas connection point is located at the bottom rear of the Broiler as shown in the diagram on the right.

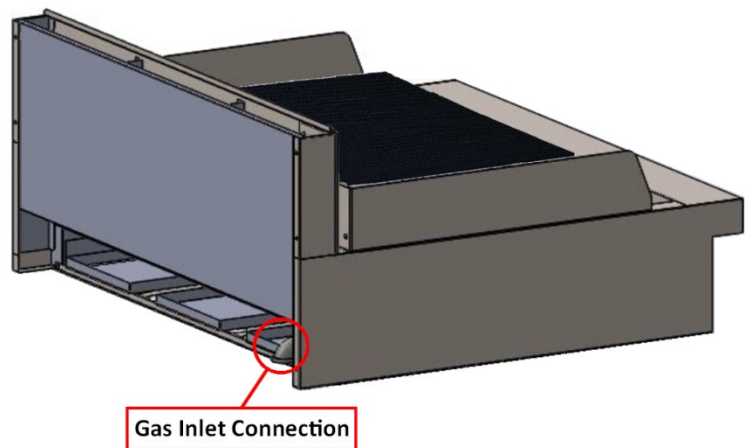

GAS CONNECTION

The appliance must be connected by an authorised person to the gas type specified on the unit. The gas type is shown adjacent to the rear gas connection point and on the data plate. Only connect to and use the specified gas type that the Broiler has been set for.

Do not remove or modify any of the gas piping within the Broiler. The gas connection must be made at the connection point provided.

Removal or modification of the gas piping within the Broiler will void the gas certification & manufacturer's warranty. This may also affect the customer's insurance policy.

The authorised person installing this equipment must comply with AS 5601 requirements. Prescribed requirements include, commission the equipment, gas leakage testing, operational checking and adjustments.

All units are tested and adjusted at the factory; however, burners and pilots must be checked at the installed location and adjusted if necessary.

INSTALLATION ON STAND

The Broiler can be installed on a stand. The Broiler is positively located on the stand by inserting four bolts from the underside of the stand into nutserts in the Broiler.

WARNING: Ensure the Broiler is fastened to the stand.

Adjustable feet are included on the leg stands and allow the unit to be levelled to the floor in the installed location. Stands with Castors are also available option.

INSTALLATION ON COUNTER TOP

The Broiler can be installed on a non-combustible counter top or refrigerated cabinet with optional 100mm adjustable counter top legs. It is recommended that the appliance is secured to the counter to prevent unintended movement

INSTALLATION CLEARANCES

The MINIMUM clearance from combustible surfaces is 150 mm rear and 250mm on either side. See diagram below.

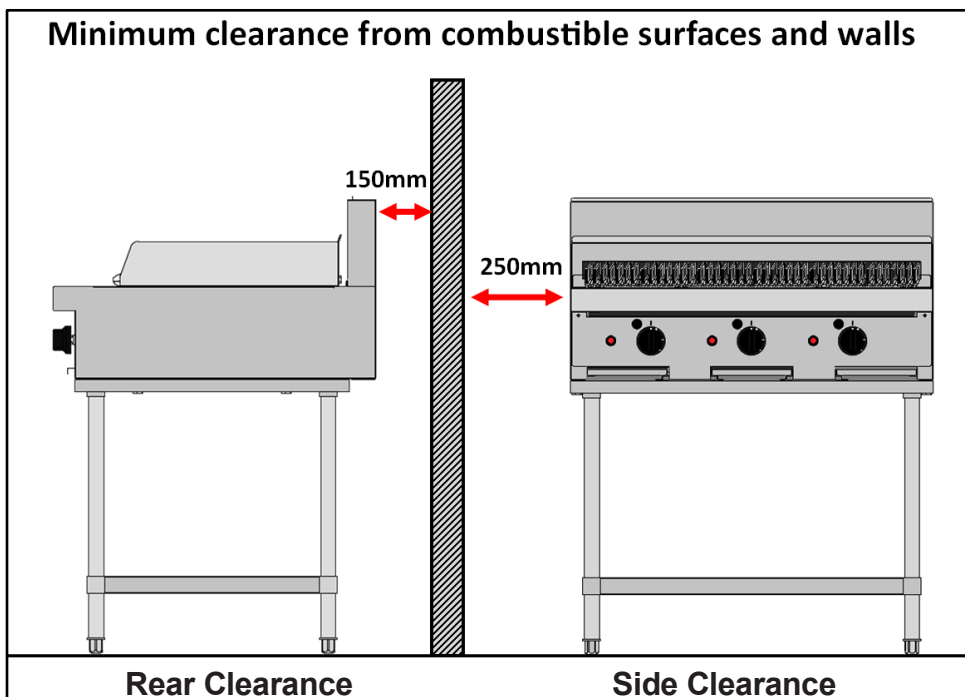
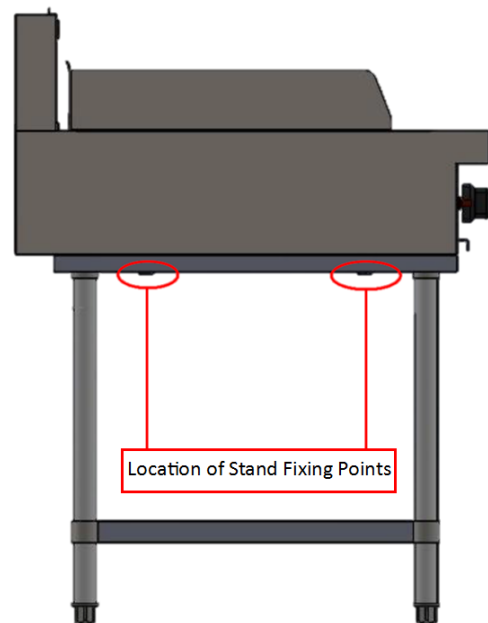

Adequate clearance must also be provided for service.

LEVELLING

To adjust the legs to level the unit to the floor and/or to slightly adjust the height of the unit, raise the front of the unit and adjust the legs (ensure safe work practices). Similarly, raise the back and adjust the legs.

DO NOT LAY THE UNIT ON ITS BACK. ENSURE THE UNIT IS LEVELLED.

COMMISSIONING

LEAK TEST

- Ensure that the valve is in the OFF position.
- Turn on the main gas supply valve.
- Light all pilots.
- Leak test the valve and fittings using approved methods.
- Correct any leaks as required and re-check.
- Shut off the gas valve

	<p>WARNING: IF YOU ARE NOT COMPETENT IN PERFORMING ANY SERVICE TASK OR REQUIRE ASSISTANCE, PLEASE CONTACT: COMCATER SERVICE</p>
--	--

TEST POINT PRESSURE

The test point is located on the gas manifold behind the control panel. The test point pressure is shown on the appliance data plate and in the Gas Configuration Table.

LOW FLAME ADJUSTMENT

The low flame adjustment screw is located on each gas valve adjacent to the control shaft. Low flame adjustment setting is shown in the Gas Configuration Table on Page 8.

GAS CONTROLS—BEHIND CONTROL PANEL

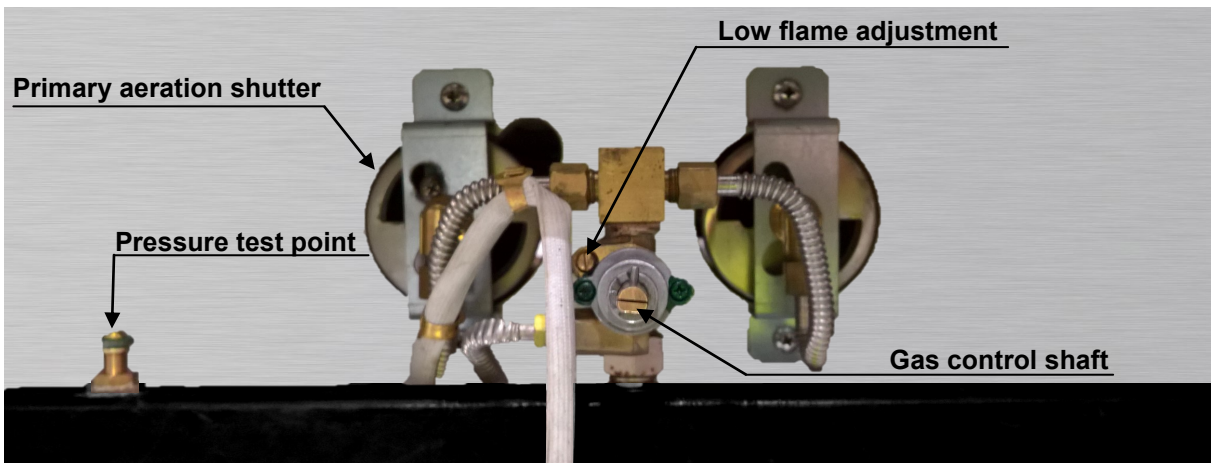



PRIMARY AIR SETTING

The Primary Aeration shutter setting is gas type specific. When converting between gas types ensure that the correct Primary Aeration setting and interrupter screw are used per the diagram below.

Primary Air Setting		Dwg Ref	Required Setting	Natural Gas	Propane Gas
Natural Gas	Aeration Shutter Setting	A	25mm		
	Interrupter Screw (length)	C	30mm		
Propane Gas	Aeration Shutter Setting	B	Fully Open		
	Interrupter Screw (length)	D	15mm		

GAS CONVERSIONS

	ONLY TO BE COMPLETED BY AN AUTHORISED PERSON
	ENSURE GAS IS ISOLATED WHILST PERFORMING CONVERSION WORK.
	PERFORM A LEAK TEST BEFORE IGNITING AND CALIBRATING BURNER AND PILOT ADJUSTEMENTS.









The RCB Series of Broilers can be converted to either Natural Gas or Propane Gas. If Gas Conversion is required, Gas conversion kits are available through Comcater Spare Parts for either gas type. Detailed Instructions are provided with the Gas Conversion kits.

RCB GAS CONVERSION KIT PART NUMBERS

Model	Natural Gas	Propane Gas
RCB4	THSP-RCB4-GCKIT-NG	THSP-RCB4-GCKIT-LP
RCB6	THSP-RCB6-GCKIT-NG	THSP-RCB6-GCKIT-LP
RCB9	THSP-RCB9-GCKIT-NG	THSP-RCB9-GCKIT-LP

The list of components below are provided in all gas conversion kits, quantities vary per model.

CONTENTS

Image	Description
	RCB GAS CONVERSION INSTRUCTIONS
	MAIN BURNER INJECTORS
	BURNER INTERRUPTER SCREW
	PILOT INJECTORS
	SPRING FOR GAS REGULATOR
 or 	GAS TYPE LABEL FOR REAR OF APPLIANCE
 or 	GAS TYPE LABEL FOR DATA PLATE

NOTE: To arrange a Gas Conversion contact Comcater Service 1800 810 161

OPERATION



FIRST TIME USE

Before lighting the Broiler for the first time, ensure that all package materials including the stainless steel protective film and moisture absorption packs have all been removed from the cooking grates and drip trays before lighting.

Use warm soapy water and a cloth to wipe down and remove any dust or metal filings that may have settled during manufacturing.

CORRECT ASSEMBLY

Before first time use ensure that all heat baffles, infrared hoods and cooking grates have not moved during transport. Incorrect alignment may affect the operation of the broiler.

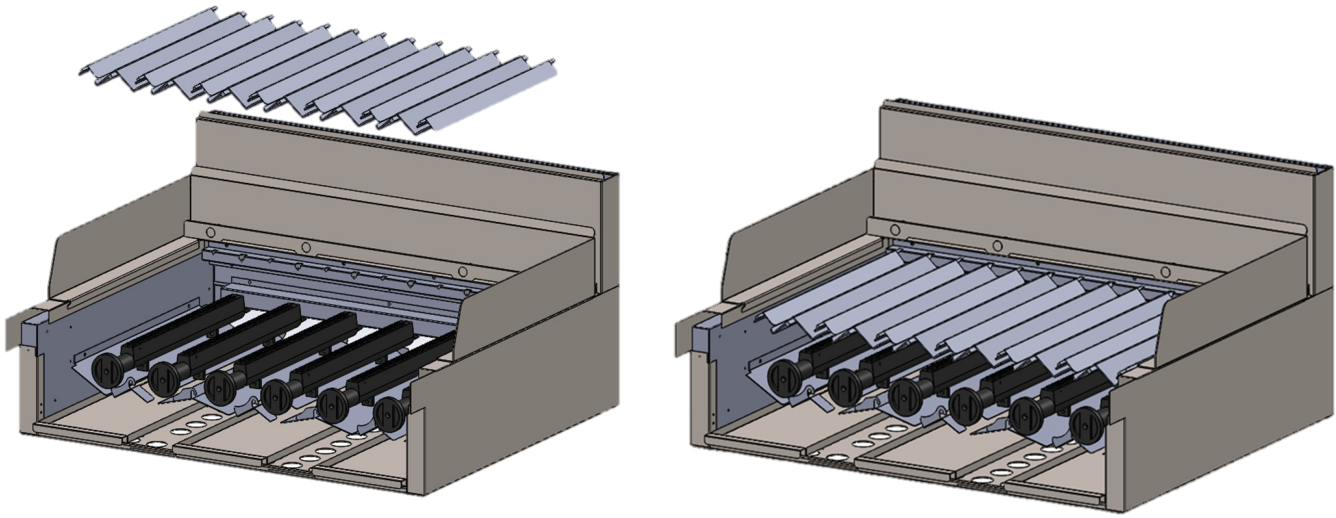

LIGHTING INSTRUCTIONS

1. Turn the Control knob from position "off" ● to "Pilot" ★.
2. Depress control knob and hold it down and light pilot immediately with "piezo ignitor".
Note: The pilot can be seen through the "pilot viewing hole".
3. Once the pilot has lit, continue to hold in the control knob for 10 seconds, before slowly releasing. (Verify that the pilot is still lit once the control knob has been released, if not repeat step 3 & 4).
4. Turn gas control knob to the "Hi-flame" 🔥 position. The burner will then ignite.
5. If the pilot becomes extinguished, repeat the above procedure.

SHUTDOWN INSTRUCTIONS

1. Turn the gas control knob to the "off" ● position.
2. Allow broiler to cool down before cleaning.

DIAGRAM - OPERATOR CONTROLS

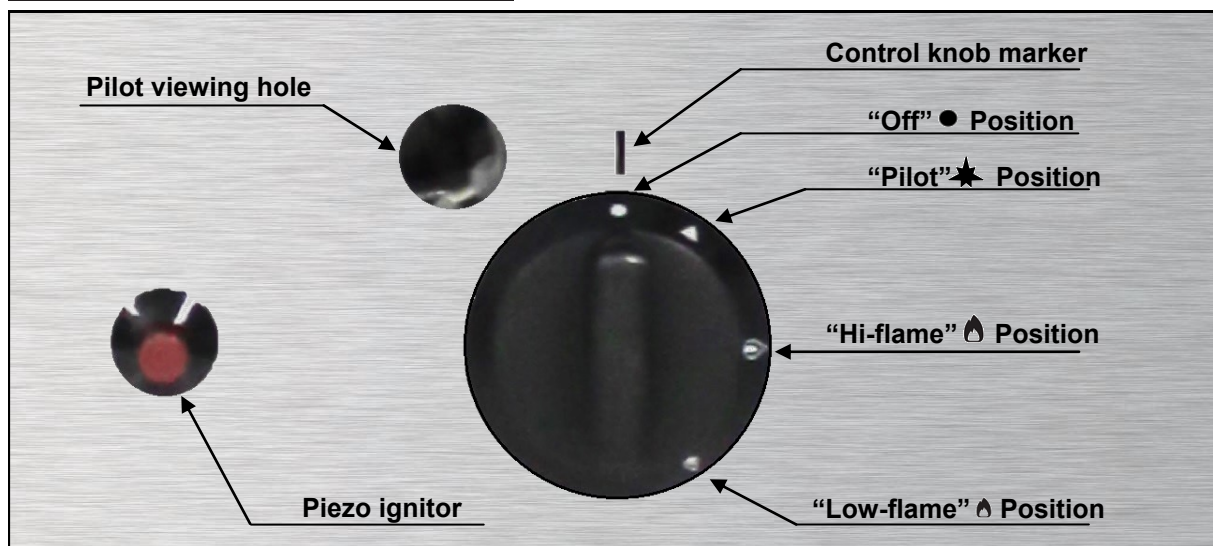



USE ONLY SUITABLE CHEMICALS AND OBSERVE ALL MANUFACTURER SAFETY REQUIREMENTS FOR SAFE HANDLING AND USE.

DAILY CLEANING

Warning: Ensure the appliance is off and the parts are cool to touch.

Warning: Cooking by-products are collected in the channel at the front of the Broiler and drain in to a removable grease drawer. Cooking by-products may also fall directly in to the grease drawer. Ensure the front channel, drainage hole and grease drawer are cleaned regularly. Ensure the grease drawer is always in position when cooking.

CLEANING BROILER GRATES, INFRARED HOODS AND BURNERS

After each use, clean the open Broiler grates with a sharp grill scraper and/or brush as necessary to remove any excess debris.

Warning: Never use liquids to clean the Broiler grates in the installed position. Remove Broiler grates for thorough cleaning in liquid.

Warning: Empty the grease drawer as necessary, clean, dry and replace. Ensure the grease drawer is always in position when cooking.

Broiler grates, infrared hoods, are all positively located and may be removed (in sequence) for service and cleaning, burners are not removable. Note: After cleaning, ensure the components are dry and re-assemble in reverse order – ensure all items are correctly and positively located. Never operate the Broiler without the infrared hoods & cooking grates installed.

Cleaning must be regular and thorough to ensure safe and efficient operation of the equipment and to prevent flare-up. The amount of usage and the type of products being cooked will largely determine how often complete cleaning is necessary - it is the operators responsibility to assess this.

To clean the items, use a suitable detergent and warm water and scrubbing brush. Repeated scrubbing will be necessary if deposits are heavy and baked on.

CLEANING STAINLESS STEEL



Regularly wipe the surface with hot water and detergent. Rinse the washed area with a wet sponge and clean water and wipe the area dry to prevent streaking. Follow this process and wash a small area at a time to prevent chemical residue and streaking.

Stainless steel may discolour if overheated. These stains can usually be removed using an appropriate powder/paste. To scrape off heavy deposits of grease and oil, use only wood or plastic tools as necessary.

Note: Never use steel wool to clean stainless steel.

Note: Damage may occur if chemicals not suitable for stainless steel are used.

MAINTENANCE

	<p>FOR YOUR SAFETY, ALL SERVICE WORK MUST BE CARRIED OUT BY AN AUTHORISED PERSON AND USE ONLY ORIGINAL SUPPLIED AND SPECIFIED PARTS.</p>
	<p>TEST ALL FITTINGS, PIPES AND PIPE CONNECTIONS FOR LEAKS IN ACCORDANCE WITH APPROVED GAS LEAK TEST PROCESSES AND METHODS. DO NOT USE A FLAME.</p>

RECOMMENDED SERVICE PLAN

It is recommended that your appliance be serviced by an authorised person every 12 months. This period is for guidance purpose only and may vary based on usage of the equipment and operator care.

Prescribed service tasks include:

- Functional test of all components, clean and adjusted as necessary
- Inspect and clean all gas valves and lubricate with an industry approved lubricant
- Inspect all gas piping
- Check and adjust specified gas pressures
- Leak test
- Full operation, performance and safety test

For all technical queries, please contact Comcater's Technical Support Team.

Technical Phone Support

Phone: 1800 810 161

Email: techsupport@comcater.com.au

TROUBLESHOOTING



Problem	Probable Causes	Corrective Action
Burner will not light	Pilot is not lit	Light the pilot as per instructions shown on the inside of the door or on Page 13 of this manual
	Gas Control is set to “Pilot”★	Ensure that the gas control dial is set to “Hi-Flame” 🔥
	No gas supplied to unit	Verify that the gas line connections are connected, ensure all shutoff valves are open, including emergency gas shut-offs. Note: some exhaust systems have a gas supply interlock fitted, that will disrupted gas supply to the equipment if the exhaust hood isn’t operating.
BROILER isn’t getting Hot, (Infrared hoods are not glowing)	Gas Control is set to the “Low flame” 🔥 setting	Ensure the gas control knob is set to the “Hi flame” 🔥 setting, low flame is used as a standby or rest feature only. When the gas control is set to the “Low flame” 🔥 Setting the infrared hoods will not glow.
	Large or small infrared hoods are incorrectly aligned or haven’t been fitted after cleaning.	When the BROILER is cool to touch, remove the cooking grates and ensure that all hoods are present and correctly positioned per diagram on page 13. If in doubt Contact Service
	Gas pressure is too low	Isolating the problem requires additional troubleshooting beyond the scope of the operator. Contact Service

For all technical queries regarding troubleshooting please contact Comcater Technical Support:
Phone: 1800 810 161 **Email:** techsupport@comcater.com.au

