



INSTALLATION & OPERATION MANUAL

**RCF4**  
GAS DEEP FRYER

# CONGRATULATIONS!



Thank you for choosing Trueheat.

This product has been specifically designed by Comcater to meet a wide range of applications and represents the best quality and highest value equipment.

Please read the Instruction Manual carefully to ensure the safe and reliable operation and performance of your equipment.

Should you require service, you will be supported by Comcater's trained and qualified service network.

## COMCATER AUSTRALIA

[www.comcater.com.au](http://www.comcater.com.au)

### National Head Office

156 Swann Drive, Derrimut, VIC 3030

Phone: 03 8369 4600

Fax: 03 8369 4699

Email: [sales@comcater.com.au](mailto:sales@comcater.com.au)

### Technical Services Group

Phone: 1800 810 161

Fax: 03 8369 4696

### Email:

[Equipment Servicing \(24/7\)](mailto:service@comcater.com.au)

[service@comcater.com.au](mailto:service@comcater.com.au)

### Equipment Spare Parts

[spares@comcater.com.au](mailto:spares@comcater.com.au)

### Technical Support

[techsupport@comcater.com.au](mailto:techsupport@comcater.com.au)

## Comcater QR Codes



Comcater Website



Log a Service Call



Online Spare Parts Store

Reproduction or copying of any part of this manual by any means whatsoever is strictly forbidden unless authorised in writing by Comcater. Comcater reserves the right to change design and specifications without prior notice. © Copyright Comcater Pty Ltd, August 2017.

# TABLE OF CONTENTS



<b>INTRODUCTION</b>	
Warranty.....	4
Date Plate Location .....	4
<b>WARNINGS</b> .....	5
<b>GENERAL INFORMATION</b> .....	6
<b>SPECIFICATIONS</b>	
Dimensions, Weight & Installation Drawings.....	7
Accessories & Optional Accessories .....	7
Gas Configuration .....	8
<b>INSTALLATION</b>	
Gas Connection .....	9
Installation Clearances .....	10
Levelling .....	10
<b>COMMISSIONING / BURNER ADJUSTMENT</b>	
Leak Test .....	11
Test Point Pressure .....	11
Pilot Adjustment .....	11
<b>GAS CONVERSION</b> .....	12
<b>OPERATION</b>	
First Time Use .....	13
Lighting Instructions .....	13
Shut Down Instructions .....	13
Diagram of Operators Controls	
Daily Operation .....	14
<b>MAINTENANCE</b>	
Daily Cleaning .....	14
Boil Out .....	14
Cleaning Behind Fryer.....	15
Recommended Service Plan .....	15
<b>TROUBLESHOOTING</b>	
Burner will not light .....	16
Pilot will not light .....	16

# INTRODUCTION



## GENERAL

The Trueheat RC Series is designed for commercial catering purposes only and incorporates a wide range of design features. It is designed to deliver high-end performance to fulfill the busy demands within a commercial kitchen. It is available in various appliances and configurations including:

Ranges with open burners, griddles with oven or as Counter-Top unit.

Broilers, salamanders, pasta cookers and deep fryers.

This versatility will satisfy a wide range of customer needs.

## WARRANTY

12 months replacement of parts including labour, for goods found to be faulty due to defective materials, manufacture and/or workmanship. This warranty is void if installation, operation and/or maintenance of the equipment are not in accordance with manufacturer's instructions and recommendations.

Unauthorised modifications to the equipment will void the warranty and product certification.

All warranty work will be undertaken in normal working hours from Monday – Friday 8:00am to 4:00pm

Warranty does not extend to:

Damages caused in shipment

Damage as a result of incorrect installation

Damage as a result of incorrect operation

Damages caused by Unauthorised service and use of non-original parts

Gas supply issues to the equipment

Calibration of thermostats after 90 days

Failure resulting from improper maintenance

Failure as a result of tampering with, removal of, or changing any pre-set control or safety device

After hours Service - **Penalty rates apply for afterhours service.**

Conditions as defined in Comcater terms and condition of sale, a copy of Comcater's terms and conditions of sale can be found at [www.comcater.com.au/terms](http://www.comcater.com.au/terms)







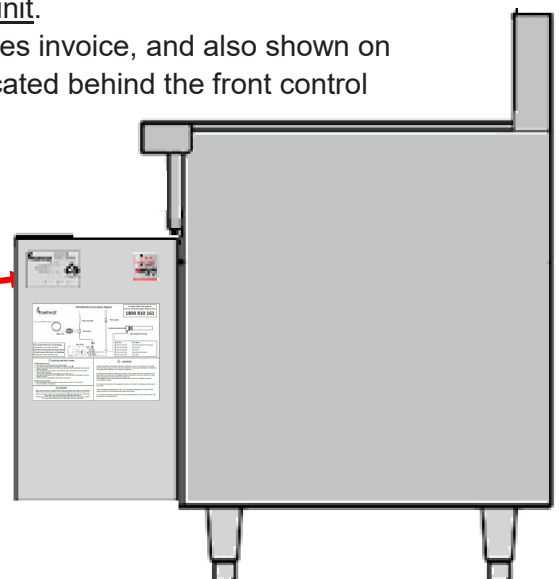
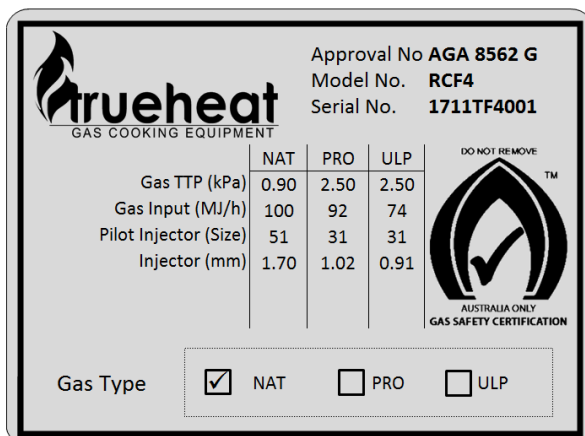

For all warranty work, authorized service, genuine and authorized spare parts, please contact Comcater Service 1800 810 161.

Please ensure you quote the Model and Serial Number of the unit.

The Model and Serial Number of the unit is recorded on the sales invoice, and also shown on the top right side of the front control panel. The data plate is located behind the front control panel.



# WARNINGS

	<p><b>IMPROPER INSTALLATION, ADJUSTMENT, ALTERATION, SERVICE OR MAINTENANCE CAN CAUSE INJURY OR DEATH. THE INSTRUCTION MANUAL MUST BE READ CAREFULLY BEFORE INSTALLING, OPERATING OR SERVICING THIS EQUIPMENT.</b></p>
	<p><b>TO BE INSTALLED ONLY BY AN AUTHORISED PERSON IN ACCORDANCE WITH AS/NZS 5601.1, LOCAL AUTHORITY, GAS, ELECTRICITY, ANY APPLICABLE STATUTORY REGULATIONS AND MANUFACTURER REQUIREMENTS.</b></p>
	<p><b>THIS EQUIPMENT IS DESIGNED FOR COMMERCIAL CATERING PURPOSES AND WILL GENERATE SIGNIFICANT HEAT. HOT SURFACES WILL CAUSE BURNS. A HAZARD AND RISK ASSESSMENT MUST BE UNDERTAKEN BY OWNERS AND ALL OPERATORS MADE AWARE OF THESE.</b></p>
	<p><b>DO NOT STORE OR USE FLAMMABLE LIQUIDS NEAR THIS APPLIANCE.</b></p>
	<p><b>DO NOT SPRAY AEROSOLS NEAR THIS APPLIANCE WHILE IT IS IN OPERATION.</b></p>
	<p><b>INSTALLATION CLEARANCES AS SPECIFIED MUST BE OBSERVED.</b></p>
	<p><b>IF YOU SMELL GAS, TURN THE UNIT OFF AND THE MAIN GAS SUPPLY VALVE TO THE UNIT. CONTACT YOUR GAS SUPPLIER OR AN AUTHORISED PERSON.</b></p>
	<p><b>BEFORE TURNING ON THE MAIN GAS SUPPLY, CHECK THE UNIT TO BE CERTAIN THAT ALL THE VALVES ARE IN THE “OFF” POSITION.</b></p>

# GENERAL INFORMATION



## INSPECTION

Please inspect the unit on receipt. If the unit is damaged, contact the carrier immediately and file a damage claim with them. Save all packing materials when filing a claim. Freight damage claims are the responsibility of the purchaser and are not covered under warranty.

## OPERATOR MANUAL

This manual contains important information for your safety and the installation, operation, maintenance and service of this equipment. Please read the manual carefully and ensure all operators of the equipment are aware of the contents and safety requirements. You must also assess all hazards and risks associated with the operation of the equipment in your environment and advise all operators of these.

## INSTALLATION

This equipment must be installed by an authorized person in accordance with AS/NZS 5601.1, local authority, gas, electricity, any applicable statutory regulations and manufacturer requirements.

## GAS CONNECTION

The appliance must be connected by an authorized person to the gas type specified on the unit. The gas type is shown adjacent to the rear gas connection point and on the data plate. Connect to and use only the correct type of gas.

## GAS PRESSURE

The authorized person installing this equipment must ensure that the gas operating pressure is the same as shown on the rating plate and that there is sufficient gas volume for the appliance to operator correctly.

## COMMISSIONING

The authorized person installing this equipment must commission the equipment in accordance with AS/NZS 5601.1 - gas leakage, operational checking, adjustments and instructing the owner on use of the equipment are prescribed requirements.

# SPECIFICATIONS



## DIMENSIONS, & INSTALLATION DRAWINGS, OPTIONAL ACCESSORIES

The following tables and drawings provide all dimension, weight and optional accessories.



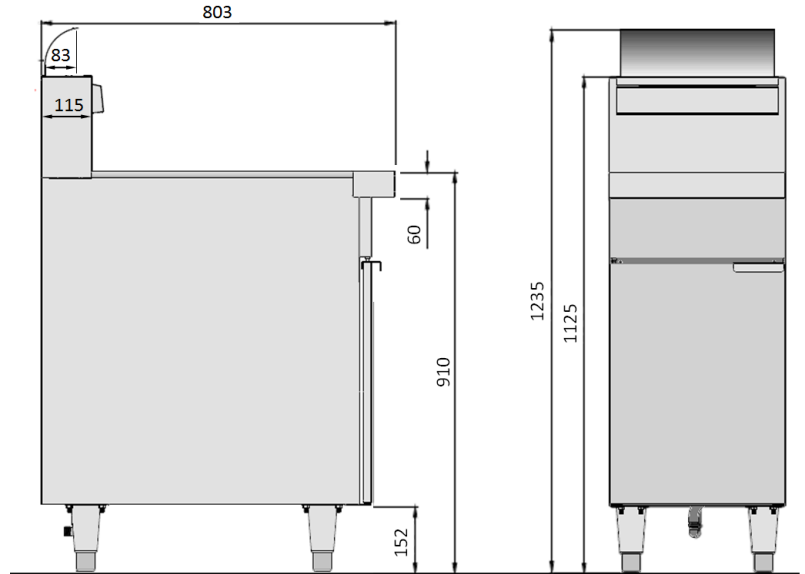



DIMENSIONS	
Width (mm)	400
Depth (mm)	803
Height (mm)	1135



## ACCESSORIES INCLUDED

DESCRIPTION	Qty
Fry basket	2
Wire basket support grid	1
Drain extension pipe	1
Clean out rod	1
Frypot Lid	1

## OPTIONAL ACCESSORIES

IMAGE	PART NO.	DESCRIPTION	QTY
	B18120	Additional Fry Basket - Black Handle	1
	S51058	Stainless Steel Fish Plate	1
	8100357	Front Castors Swivel with brake	2
	8100378	Rear Castors Fixed without brake	2
	S37416	Fryer capping strip — Joins two fryers	1
	S37417	Fryer reversible side splash shield	1
	432018-900HK	900mm 3/4" flexible gas hose with quick connect fittings & restraint	1
	432018-1200HK	1200mm 3/4" flexible gas hose with quick connect fittings & restraint	

# SPECIFICATIONS (cont'd)

## GAS CONFIGURATION

	<b>TO BE COMPLETED BY AN AUTHORISED PERSON.</b>
---	---

	<b>ONLY CONNECT THE APPLIANCE TO THE GAS TYPE IT HAS BEEN CONFIGURED FOR. THE GAS TYPE IS SPECIFIED ON THE DATA PLATE AND AT THE REAR OF THE APPLIANCE.</b>
---	---

	NATURAL GAS	PROPANE GAS	UNIVERSAL LPG
<b>Minimum Gas Inlet Pressure</b>	1.13 kPa	2.75 kPa	2.75 kPa
<b>Test Point Pressure</b>	1.00 kPa	2.50 kPa	2.50 kPa

Description	NATURAL GAS	PROPANE GAS	UNIVERSAL LPG
Gas Consumption	100 MJ/h	92MJ/h	74 MJ/h
Main Injector	1.70 mm	1.02 mm	0.91
Pilot Orifice (Adjustable)	0.51 mm	0.31 mm	0.31 mm
Pilot Adjustment	3 turns out from fully in	3 turns out from fully in	3 turns out from fully in
Commissioning Procedure - Regulator Adjustment	Set the gas pressure at the main gas valve while the burner is running.	Set the gas pressure at the main gas valve while the burner is running.	Set the gas pressure at the main gas valve while the burner is running.

**Note:** When checking gas pressure, ensure that all other equipment on the same line is turned “ON”.



# INSTALLATION



**THIS EQUIPMENT MUST BE INSTALLED BY AN AUTHORIZED PERSON IN ACCORDANCE WITH AS/NZS 5601.1, LOCAL AUTHORITY, GAS, ELECTRICITY, ANY APPLICABLE STATUTORY REGULATIONS AND MANUFACTURER REQUIREMENTS.**

**Note:** Installation is the responsibility of the owner.

## GAS INLET CONNECTION

1/2" BSP Male.

## GAS CONNECTION POINT

The gas connection point is located lower at the bottom rear of the appliance.

## GAS CONNECTION

The appliance must be connected by an authorised person to the gas type specified on the unit. The gas type is shown adjacent to the rear gas connection point and on the data plate. Only connect to and use the specified gas type that the appliance has been set for.

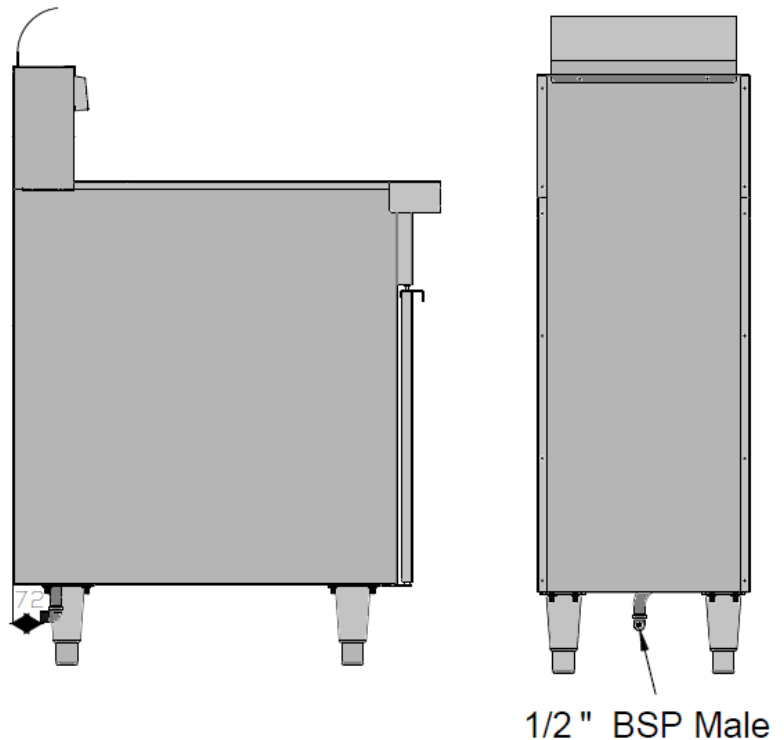

Do not remove or modify any of the gas piping within the appliance. The gas connection must be made at the connection point provided.

Removal or modification of the gas piping within the appliance will void the gas certification & manufacturer's warranty. This may also affect the customer's insurance policy.

The authorised person installing this equipment must comply with AS/NZS 5601.1 requirements. Prescribed requirements include, commission the equipment, gas leakage testing, operational checking and adjustments.

All units are tested and adjusted at the factory; however, burners and pilots must be checked at the installed location and adjusted if necessary.

# INSTALLATION

## INSTALLATION CLEARANCES

The MINIMUM clearance from combustible surfaces is 150 mm rear and 150mm on either side. Where castors are used on installations where combustions are adjacent, ensure that a stand off isolated behind the appliance to ensure that the customer can reposition the closer than 150mm.

See diagram below.

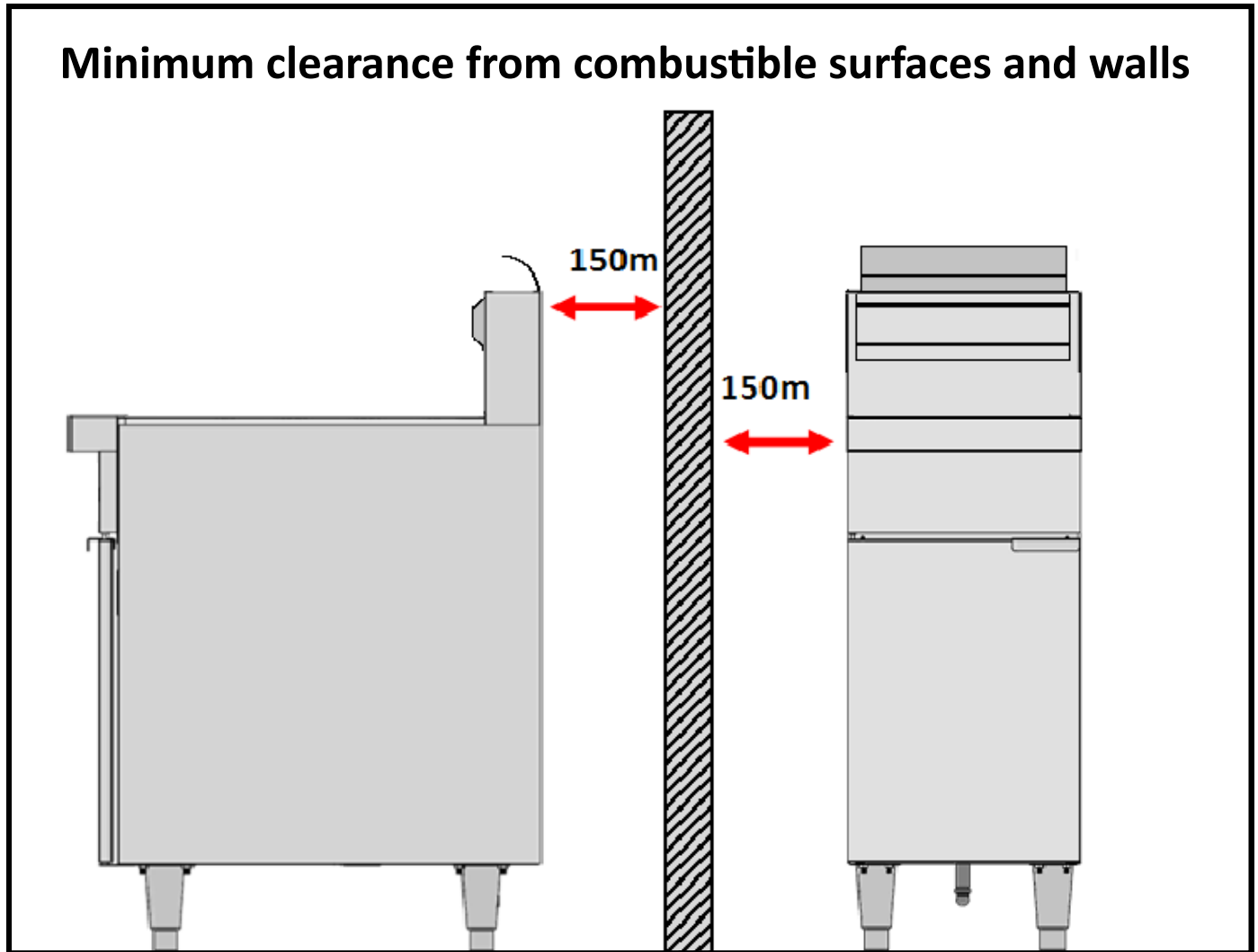

### NOTE:

Ensure adequate clearance is provided for service & maintenance.

### LEVELLING

To adjust the legs to level the unit to the floor and/or to slightly adjust the height of the unit, raise the front of the unit and adjust the legs (ensure safe work practices). Similarly, raise the back and adjust the legs.

Castors are non-adjustable and should only be used when are floors level.

**DO NOT LAY THE UNIT ON ITS BACK. ENSURE THE UNIT IS LEVELLED AND STABLE.**

# COMMISSIONING

## LEAK TEST

Ensure that the valve is in the OFF position.  
Turn on the main gas supply valve.  
Light the pilot.  
Leak test the valve and fittings using approved methods.  
Correct any leaks as required and re-check.  
Turn the gas valve to the OFF position



**WARNING:**  
**IF YOU ARE NOT COMPETENT IN PERFORMING ANY SERVICE TASK OR REQUIRE ASSISTANCE, PLEASE CONTACT: COMCATER SERVICE**

## TEST POINT PRESSURE

The test point used for setting the burner pressure is located on the gas control valve and is accessed behind the door. The test point pressure is shown on the appliance data plate and in the Gas Configuration Table on Page 8.

## PILOT FLAME ADJUSTMENT

The Pilot flame adjustment screw is located on the gas control valve, shown in the diagram below. Details on the correct setting are shown in the gas configuration table on page 8.

## DIAGRAM - MEASUREMENT & ADJUSTMENT

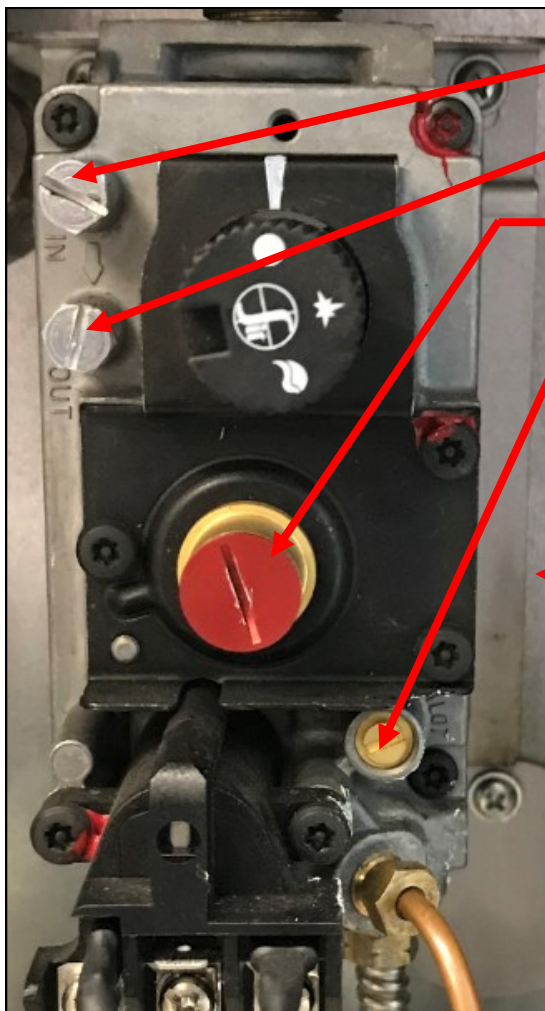

Gas Inlet Pressure Test Point

Burner Pressure Test Point



Burner Pressure Adjustment

Pilot Flame Adjustment Screw

Location of Gas Controls behind Door



# GAS CONVERSIONS

	<b>ONLY TO BE COMPLETED BY AN AUTHORISED PERSON</b>
	<b>ENSURE GAS IS ISOLATED WHILST PERFORMING CONVERSION WORK.</b>
	<b>PERFORM A LEAK TEST BEFORE IGNITING AND CALIBRATING BURNER AND PILOT ADJUSTEMENTS.</b>









The RCF4 Fryer can be configured to operate on either Natural Gas, Propane Gas or Universal LPG.

If a Gas Conversion is required, Gas conversion kits are available through Comcater Spare Parts for either gas type. Detailed conversion Instructions are provided with the Gas Conversion kits.

## RCF4 GAS CONVERSION KIT PART NUMBERS

MODEL	NATURAL GAS	PROPANE GAS	UNIVERSAL LPG
RCF4	THSP-RCF4-GCKIT-NG	THSP-RCF4-GCKIT-LP	THSP-RCF4-GCKIT-ULP

## CONTENTS

Image	Description
	RCF GAS CONVERSION INSTRUCTIONS
	MAIN BURNER INJECTORS
	PILOT INJECTOR
	REGULATOR SPRING KIT FOR GAS VALVE
 or 	GAS TYPE LABEL FOR REAR OF APPLIANCE
 or 	GAS TYPE LABEL FOR DATA PLATE

NOTE: To arrange a Gas Conversion contact Comcater Service 1800 810 161

# OPERATION

## FIRST TIME USE

Before lighting the equipment for the first time, ensure that all package materials including the stainless steel protective film have been removed before lighting.

Before filling the fryer with cooking oil for first use, ensure that the frypot is cleaned with warm soapy water and a cloth to remove any metal filings or dust that may have settled during manufacturing.

1. Once cleaned, remove all traces of water from the frypot.
2. Insert basket support wire grid or fish plate (optional accessory) into frypot.
3. Ensure that drain valve is closed, before filling the frypot with cooking oil or shortening.

## LIGHTING INSTRUCTIONS

1. Turn the Control knob from position "OFF" ● to "PILOT" ★.
2. Depress control knob and hold it down and light pilot immediately with "piezo ignitor".  
Note: The pilot can be seen through the "pilot viewing hole".
3. Once the pilot has lit, continue to hold in the control knob for 10 seconds, before slowly releasing. (Verify that the pilot is still lit once the control knob has been released, if not repeat step 3 & 4).
4. Turn gas control knob to "ON" 🔥 position, the burner will then ignite.
5. If the pilot becomes extinguished, repeat the above procedure.

## SHUTDOWN INSTRUCTIONS

1. Turn the gas control knob to the "OFF" ● position.
2. Allow the equipment to cool down before cleaning.

## DIAGRAM - OPERATOR CONTROLS

### GAS CONTROL KNOB

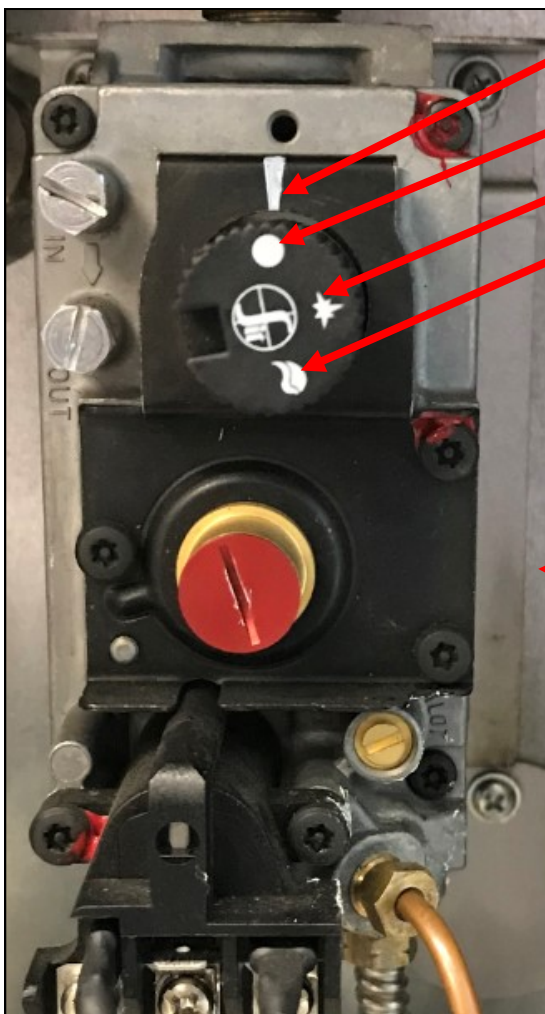

- Selection Mark
- "OFF" Position
- "PILOT" Position
- "ON" Position

### THERMOSTAT

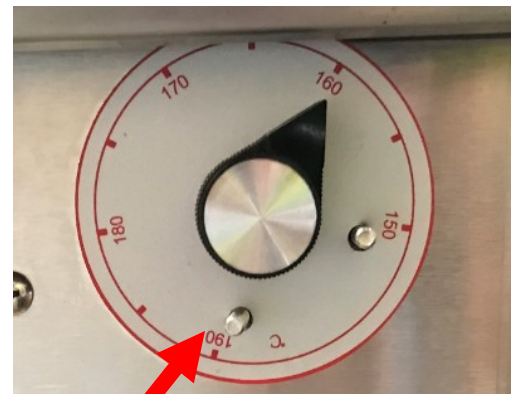

View behind door of Fryer



# OPERATION / MAINTENANCE



## DAILY OPERATION

1. Close drain valve tightly and fill frypot to oil level line with cooking oil. If solid shortening is being used, either pre-melt the solid block or slice the solid shortening into thin flakes to fill the frypot. Ensure that the solid shortening is tightly packed against heat transfer surfaces.  
**Do not place the entire solid shortening block into frypot.**
2. Turn on main burner (see lighting instruction plate), set thermostat for desired oil temperature, and wait for set-point temperature is reached before starting to cook. Do not turn on the main burner unless heating surfaces are covered with liquid. If solid shortening is used, turn the main burner off immediately if shortening begins to smoke when melting.
3. After food is fried, drain basket by hanging it a basket support. **Do not bang the basket on the fryer to drain oil**, any damage caused to fryer from banging the basket is not covered by warranty.
4. When food service period is over, turn the main gas valve to the 'PILOT' position, except for prolonged shutdown. This will extend life of components in the safety pilot system.
5. Do not allow floating crumbs to accumulate.
6. Do not allow grease to accumulate or harden on frame, body or flue front of fryer.
7. Drain fryer by filtering hot oil through Filter Cone daily or with use of a portable filter. Remove all residues from frypot using the cleaning brush provided. Wipe down the frypot with a cloth or paper towel.
8. Before oil is returned to frypot, ensure frypot is clean. This prolongs oil life.
9. Cover frypot with lid provided while not in use.



**USE ONLY SUITABLE CHEMICALS AND OBSERVE ALL  
MANUFACTURER SAFETY REQUIREMENTS  
FOR SAFE HANDLING AND USE.**

## DAILY CLEANING

Extend the life of your fryers and fryer oil by cleaning fryers and filtering oil on a daily basis. Use a test kit to determine when to change your fryer oil. It is recommended to use a commercial filter daily to prolong the life of oil.

1. Remove accumulated food particles from the frypot on a regular basis. When sediment accumulates, the energy efficiency of the fryer is reduced.
2. Drain frypot into a filter and scrub thoroughly at least once daily or as often as necessary to remove all food particles and sediment from the frypot.
3. Wipe down all metal surfaces to remove accumulation of oil and dust.
4. If necessary use the clean out rod provided to clear the drain from inside the frypot.
5. If more thorough cleaning is needed, use a mixture of solution of detergent and hot water.
6. Ensure to remove all water and solution from the frypot. Dry thoroughly with cloth, not by burner heat.
7. Clean outside of the cabinet with a clean, damp cloth soaked with dishwashing detergent.

## BOIL-OUT

Completing a weekly Boil-out will keep the frypot clean of carbon, which will assist with maintaining the fryers maximum performance, efficiency and oil life.

1. To complete a boil-out, drain and dispose of the oil cooking oil from the frypot.
2. With the frypot empty, close the drain valve and fill the frypot with fresh water to the full mark. Add one cup of fryer boil-out solution or food grade degreaser.
3. Turn on the gas control knob to "ON", allow the water to simmer, then turn gas control to "PILOT", and allow hot water to settle for 15 - 30 minutes.
4. Turn gas valve control to off position, then drain and rinse thoroughly with fresh water.
5. Wipe pot surfaces with a dry cloth, and ensure no traces of water remain before refilling with cooking oil or shortening fat.



# MAINTENANCE & SERVICE



## CLEANING BEHIND FRYER

If the fryer is installed on castors, it is recommended to conduct weekly cleaning behind the fryer.

1. While the fryer is empty, release the front castor brakes, and carefully move the fryer forward.
2. Isolate the main gas supply before to the flexible gas hose to the fryer.
3. Clean the floor and rear of fryer with a diluted food graded degreaser.
4. Inspect the flexible gas hose for damage. If any damage is identified, leave the gas supply to the fryer off, place an out of service tag on the gas shut off valve and contact a licensed gas fitter to replace the flexible gas hose.
5. Once cleaning is complete, carefully move the fryer back into position, making sure that the flexible gas hose isn't dragging on the floor or being kinked as the fryer is returned into position.

	<p><b>FOR YOUR SAFETY, ALL SERVICE WORK MUST BE CARRIED OUT BY AN AUTHORISED PERSON AND USE ONLY ORIGINAL SUPPLIED AND SPECIFIED PARTS.</b></p>
	<p><b>TEST ALL FITTINGS, PIPES AND PIPE CONNECTIONS FOR LEAKS IN ACCORDANCE WITH APPROVED GAS LEAK TEST PROCESSES AND METHODS. DO NOT USE A FLAME.</b></p>

## RECOMMENDED SERVICE PLAN

It is recommended that your appliance be serviced by an authorised person every 12 months. This period is for guidance purpose only and may vary based on usage of the equipment and operator care. Prescribed service tasks include:

1. Functional test of all components and clean as necessary
2. Inspect and clean all gas valves and lubricate with an industry approved lubricant
3. Inspect all gas piping
4. Check and adjust specified gas pressures
5. Check and adjust thermostat calibration
6. Leak test
7. Inspect underside of Frypot
8. Inspect Flue way
9. Full operation, performance and safety test

For all technical queries, please contact Comcater Technical Support.

### Technical Support

Phone: 1800 810 161

Fax: 03 8369 4696

Email: [techsupport@comcater.com.au](mailto:techsupport@comcater.com.au)

# TROUBLESHOOTING



Problem	Probable Causes	Corrective Action
Burner will not light	Pilot is not lit	Light the pilot as per instructions shown on the inside of the door or on page 13 of this manual
	Gas Control is set to "Pilot" ★	Open the fryer door and ensure that the gas control dial is set to "On" 🔥
	Thermostat is set to "off" or to a low temperature	Open the fryer door and ensure the temperature is set to the desired set point
	No gas being supplied to unit	Verify that the gas line connections are connected, ensure all shutoff valves are open, including emergency gas shut-offs. Note: some exhaust systems have a gas supply interlock fitted, that will disrupted gas supply to the equipment if the exhaust hood isn't operating.
Fryer never reaches frying temperature.	Failed thermostat or thermostat out of calibration.	Isolating the problem requires additional troubleshooting beyond the scope of the operator. Contact Service
Fryer is heating normally, but is loud during ignition.	Flue way is obstructed	Check the flue way for objects that may have fallen and obstructed the flue. If in doubt Contact Service
	Gas pressure is too low	Isolating the problem requires additional troubleshooting beyond the scope of the operator. Contact Service
	The openings beneath the fryer is being obstructed	Check beneath the fryer for objects that may have slide beneath the fryer and are restricting air flow to the vents beneath the base.

**For all technical queries regarding troubleshooting please contact Comcater Technical Support:  
 Phone: 1800 810 161 Email: techsupport@comcater.com.au**





