

The Australian owned and designed Trueheat RC Series of Gas Cooking Equipment has been developed to meet the operation needs and highest standards demanded by chefs and restaurant owners within a commercial kitchen.

Sturdy range matched infill bench with stand.

Note: Legs, feet and shelf can be removed to allow infill bench to be suspended between units on either side. (Hardware not included).

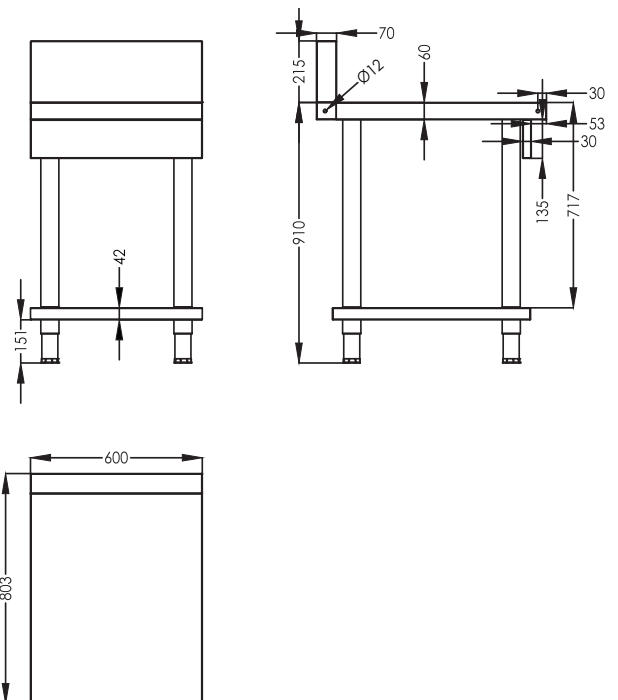

#### DIMENSIONS & WEIGHT

Working Dimension: 910mm (+/- 15mm with stand)

External Dimension: 600W x 803D x 1125H mm

Net Weight: 22kg

#### SHIPPING DATA

Shipping Weight: 26kg

Shipping Dimensions: 695W x 935D x 310H mm

SPECIFICATIONS ARE SUBJECT TO CHANGE WITHOUT NOTICE.